

OLYMPUS®

Your Vision, Our Future

Inverted Metallurgical Microscope

GX53

Advanced Microscopy Solutions for Metallurgy Inspection

NEW

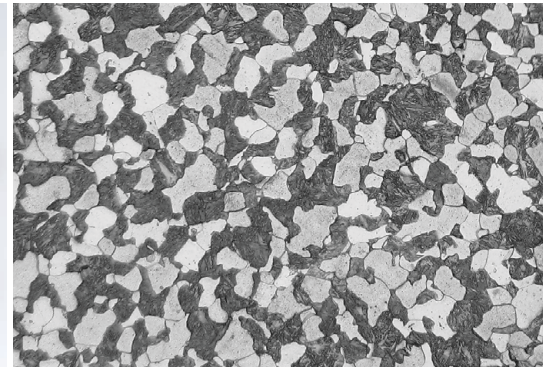
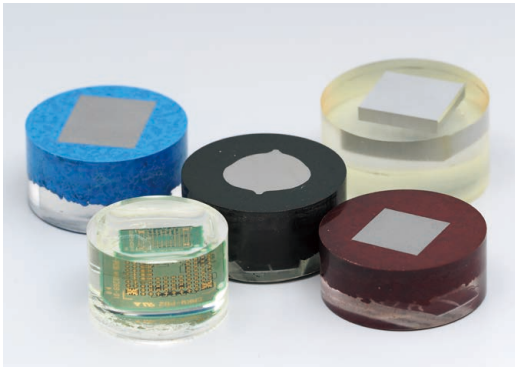

Quick analysis for large or thick sample materials

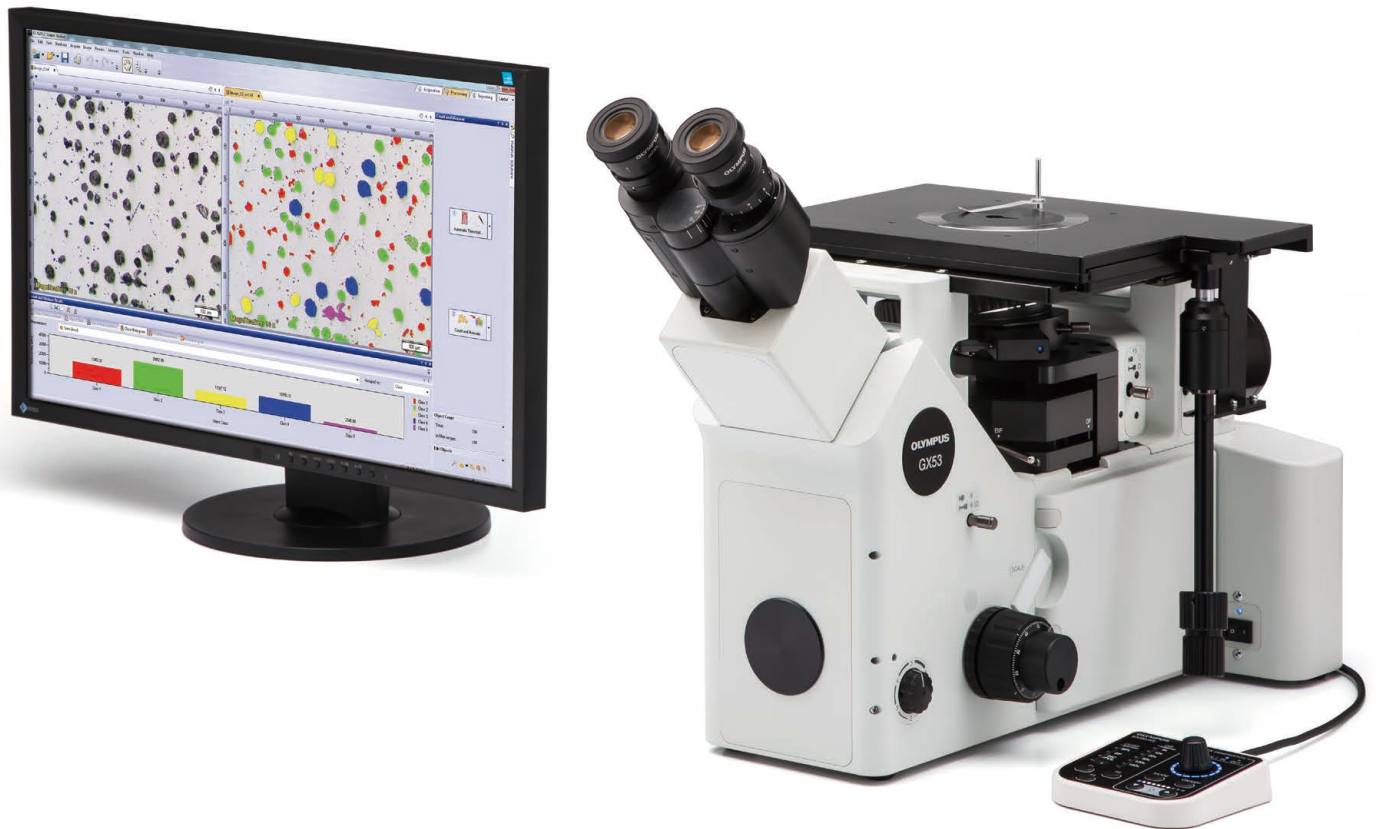

The GX53 inverted microscope is used for a wide range of applications often seen in the steel, automotive, electronics, and other manufacturing industries. The microscope enables users to inspect polished metals and cross-section samples simply by placing them upside down on the stage. The sample does not need to be leveled and can be thick, large, or heavy.

The GX53 delivers crisp images that can be difficult to capture using conventional microscopy observation methods. When combined with OLYMPUS Stream image analysis software, the microscope streamlines the inspection process from observation to image analysis and reporting.



Functions marked with this icon require OLYMPUS Stream software

Streamline Your Inspection Process

Fast Inspections, Advanced Functionality

Quickly observe, measure, and analyze metallurgical structures.

User-Friendly

Even novice operators can comfortably make observations, analyze results, and create reports.

Advanced Imaging Technology

Our proven optics and imaging technology deliver clear images and reliable results.

Modular

Choose the components you need for your application.

Fast Inspections, Advanced Functionality

Advanced Analysis Tools

The GX53 microscope's various observation capabilities provide clear, sharp images, so users can reliably detect defects in their samples. OLYMPUS Stream image analysis software's new illumination techniques and image acquisition options give users more choices for evaluating their samples and documenting their findings.

The Invisible Becomes Visible: MIX Technology

MIX technology produces unique observation images by combining darkfield with another observation method, such as brightfield or polarization. MIX observation enables users to view samples that are difficult to see with conventional microscopes, and represents even small height differences of sample surfaces. The circular LED illuminator used for darkfield observation has a directional darkfield function where one or more quadrants are illuminated at a given time. This reduces a sample's halation and is useful for visualizing its surface texture.

Cross-section of a printed circuit board

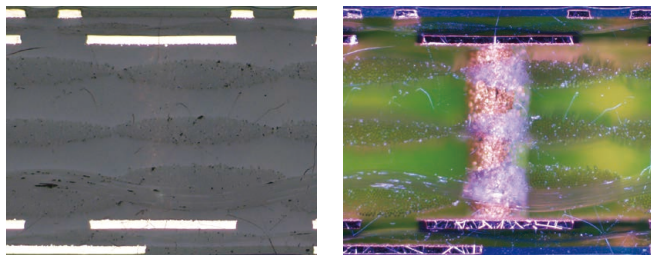

Brightfield

The substrate layers and through hole are invisible.



Darkfield

The traces are invisible.

Stainless steel

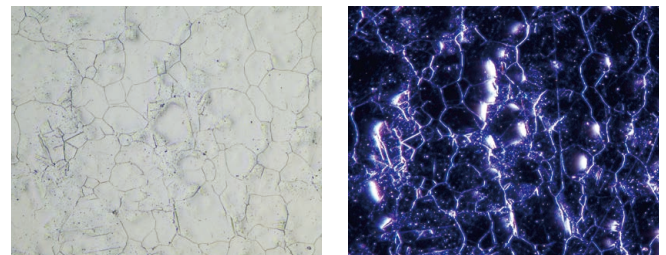

Brightfield

The texture is unobservable.



Quadrant illumination of darkfield

The color information is eliminated.

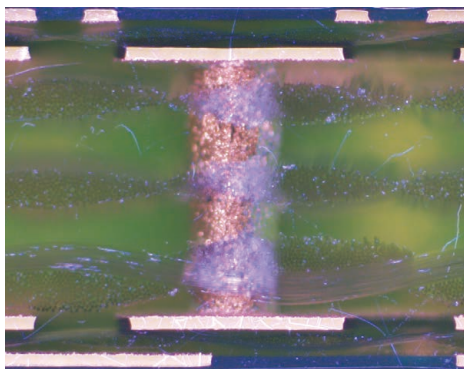

MIX: Brightfield + Darkfield

All the components are clearly represented.

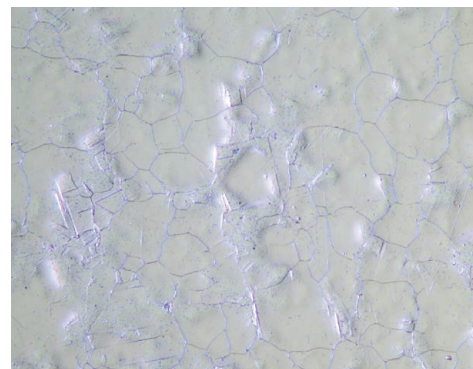

MIX: Brightfield +
Quadrant illumination of darkfield

Both the material color and texture are visible.

Easily Create Panoramic Images: Instant MIA



With multiple image alignment (MIA), users can stitch images together quickly and simply by moving the XY knobs on the manual stage—a motorized stage is optional. OLYMPUS Stream software uses pattern recognition to generate a panoramic image, which is suitable for inspections of carburizing and metal-flow conditions.

Metal flow of a bolt

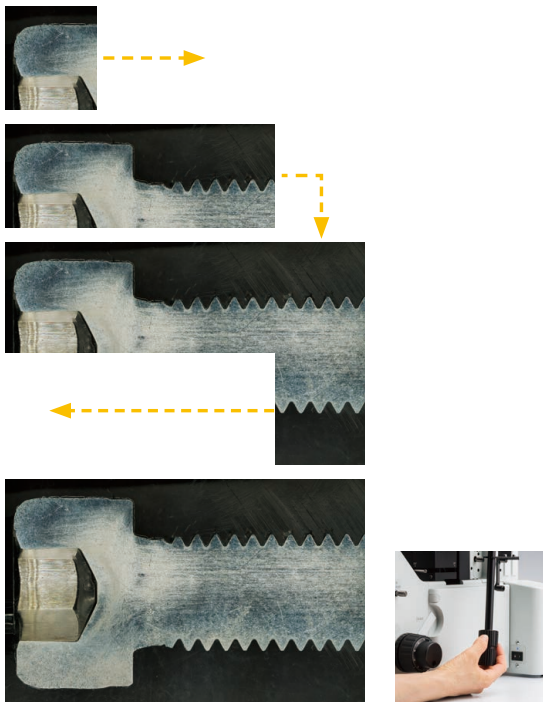

The full condition of metal flow can be seen.

Create All-in-Focus Images: EFI



OLYMPUS Stream software's extended focus imaging (EFI) function captures images of samples whose height extends beyond the depth of focus. EFI stacks these images together to create a single all-in-focus image of the sample. Even when analyzing a cross-section sample with an uneven surface, EFI creates fully-focused images. EFI works with either a manual or motorized Z-axis and creates a height map to easily visualize structures.

Resin parts

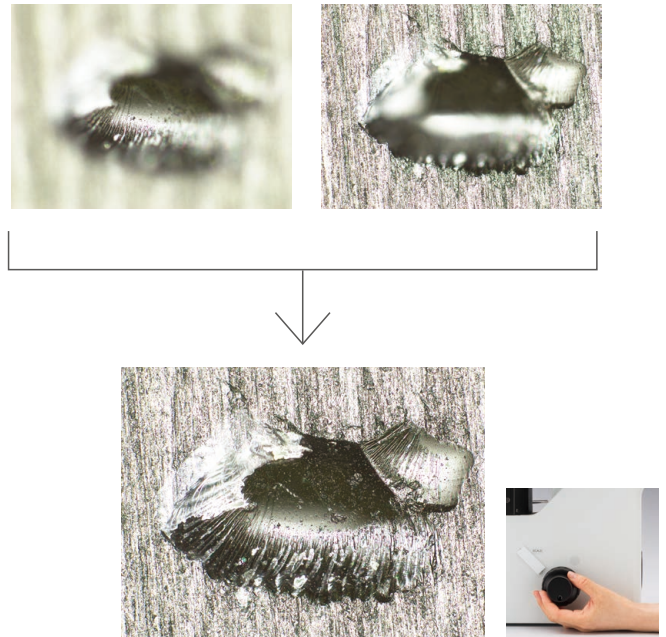

Fully focused image

Capture Both Bright and Dark Areas Using HDR



Using advanced image processing, high dynamic range (HDR) adjusts for differences in brightness within an image to reduce glare. It also helps boost the contrast in low-contrast images. HDR can be used to observe minute structures in electric devices and identify metallic grain boundaries.

Gold plate

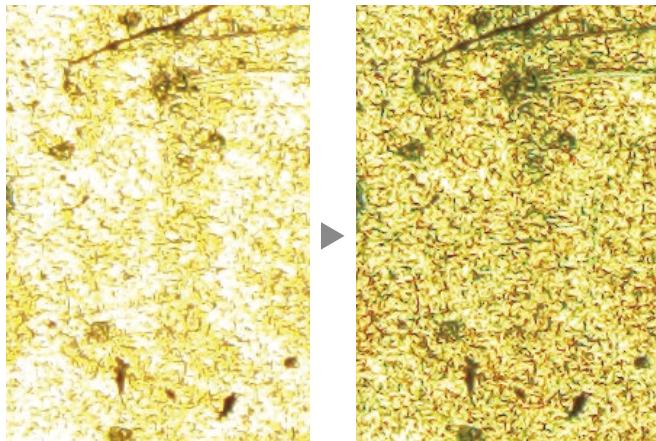

Some areas have glare.

Both dark and bright areas are clearly exposed using HDR.

Chromium diffusion coating

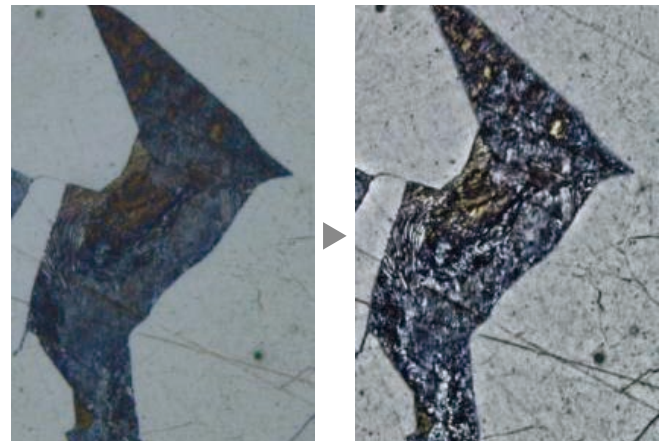

Low contrast and unclear.

Enhanced contrast with HDR.

OLYMPUS Stream Software – Optimized for Materials Science



Material inspection, measurement, and analysis are required to comply with industrial standards as well as internal operating procedures. Together, the GX53 microscope and OLYMPUS Stream software support metallurgical analysis methods that comply with different industrial standards. With step-by-step operator guidance, users can analyze their samples quickly and easily.

Particle Analysis – Count and Measure Solution

Detecting objects and measuring size distribution are among the most important applications in digital imaging. OLYMPUS Stream software's Count and Measure solution uses advanced threshold methods to reliably separate objects, such as particles and scratches, from the background. More than 50 different object measurement and classification parameters are available including shape, size, position, and pixel properties.

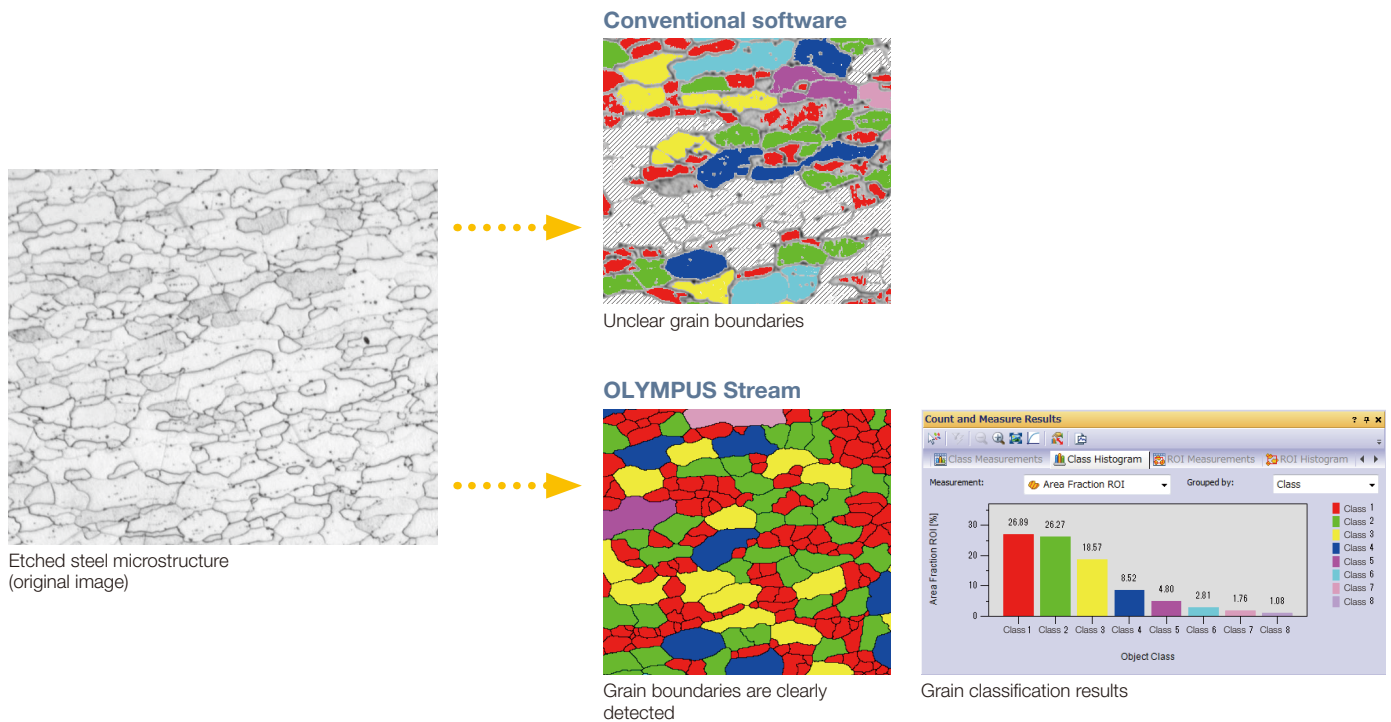

Grain Sizing in a Microstructure

Users can measure the grain size and analyze the microstructure of aluminum, steel crystal structures, such as ferrite and austenite, and other metals.

Supported standards: ISO, GOST, ASTM, DIN, JIS, GB/T

Microstructure of ferritic grains

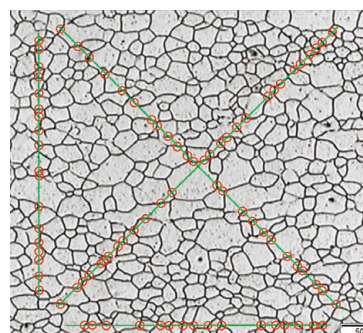

Grain sizing intercept solution

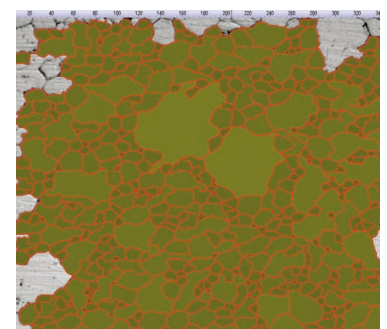

Grain sizing planimetric solution

Evaluating Graphite Nodularity

The software can be used to evaluate the graphite nodularity and content in cast iron samples (nodular and vermicular). The form, distribution, and size of graphite nodes can be classified.

Supported standards: ISO, NF, ASTM, KS, JIS, GB/T

Ductile cast iron showing nodular graphite

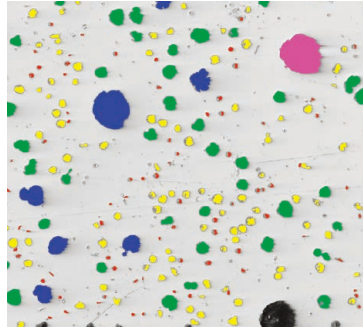

Cast iron solution

Rating Nonmetallic Inclusion Content in High-Purity Steel

Classify nonmetallic inclusions using an captured image of the worst field or inclusion that you have manually located on the sample.

Supported standards: ISO, EN, ASTM, DIN, JIS, GB/T, UNI

Steel with nonmetallic inclusions

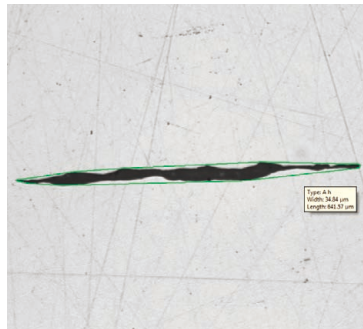

Inclusion worst field solution

Compare Images of Your Sample and Reference Images

Easily compare live or still images with auto-scaled reference images. This solution includes reference images in accordance with various standards. The solution also supports multiple modes, including live overlay display and side-by-side comparison. Additional reference images can be purchased separately.

Supported standards: ISO, EN, ASTM, DIN, SEP

Steel with nonmetallic inclusions



Chart comparison solution

Microstructure with ferritic grains

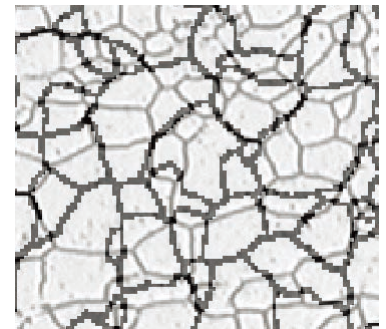

Chart comparison solution

Material Solution Specifications*

Solutions	Supported standards
Grain intercept	ISO 643: 2012, JIS G 0551: 2013, JIS G 0552: 1998, ASTM E112: 2013, DIN 50601: 1985, GOST 5639: 1982, GB/T 6394: 2002
Grain planimetric	ISO 643: 2012, JIS G 0551: 2013, JIS G 0552: 1998, ASTM E112: 2013, DIN 50601: 1985, GOST 5639: 1982, GB/T 6394: 2002
Cast iron	ISO 945-1: 2010, ISO 16112: 2017, JIS G 5502: 2001, JIS G 5505: 2013, ASTM A247: 16a, ASTM E2567: 16a, NF A04-197: 2004, GB/T 9441: 2009, KS D 4302: 2006
Inclusion worst field	ISO 4967 (method A): 2013, JIS G 0555 (method A): 2003, ASTM E45 (method A): 2013, EN 10247 (methods P and M): 2007, DIN 50602 (method M): 1985, GB/T 10561 (method A): 2005, UNI 3244 (method M): 1980
Chart comparison	ISO 643: 1983, ISO 643: 2012, ISO 945: 2008, ASTM E 112: 2004, EN 10247: 2007, DIN 50602: 1985, ISO 4505: 1978, SEP 1572: 1971, SEP 1520: 1998
Coating thickness	EN 1071: 2002, VDI 3824: 2001

*Please see the OLYMPUS Stream brochure for more detailed information.

User-Friendly

A Design That Emphasizes User Comfort

The microscope's ergonomic design helps users stay comfortable while they work, contributing to a more efficient inspection. When used with OLYMPUS Stream software, operators can easily acquire images of diverse samples, conduct a variety of analyses, and generate professional reports.

■ Maintain a comfortable posture

The tilting observation tube's extensive range and adjustable eyepoint enable operators to sit or stand at the microscope in a comfortable posture.



■ Observe large, heavy samples

Samples up to 5 kg can be inspected simply by placing the polished surface on the stage.

■ Helps prevent objective collisions

The stage mirror helps make it easier to adjust the observation point and objective magnification. It also helps prevent the objective from colliding with the sample.



■ Easily switch observation methods

The microscope supports brightfield, darkfield, differential interference contrast (DIC), and simple polarized light observations. Use a dedicated level to quickly switch between brightfield and darkfield. Add DIC simply by adding a slider.



■ Instantly record observation images

With the touch of a button (optional), observed images can be instantly saved.



■ Convenient hand switch

Control MIX illumination, the objectives, and OLYMPUS Stream functions using the available hand switch.



■ Easily control the stage during observation

Use the dedicated handle to control the stage while you are looking through the eyepieces.

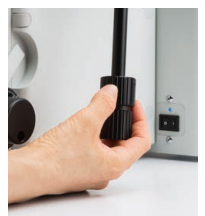



Easily Restore Microscope Settings: Coded Hardware

Coded functions integrate the microscope's hardware settings with OLYMPUS Stream image analysis software. The observation method, illumination intensity, and magnification can be recorded by the software and stored with the associated images. Since the settings can easily be reproduced, different operators can conduct the same quality inspections with limited training.

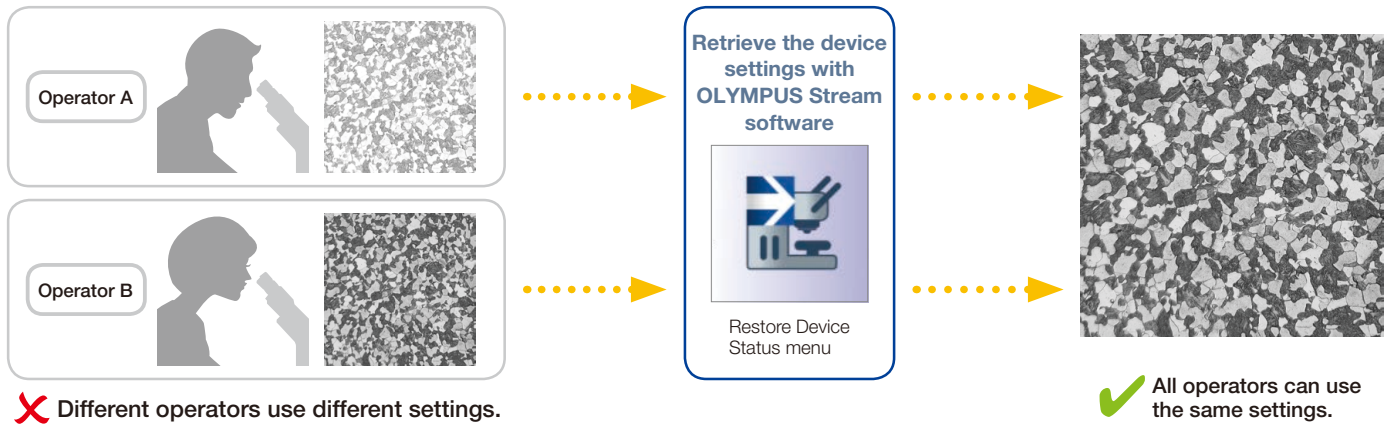

User Guidance Helps Simplify Advanced Analysis

The software guides users step-by-step through an inspection process that complies with the chosen industrial standard. Operators at any experience level can quickly and easily conduct advanced analysis by following the on-screen guidance.

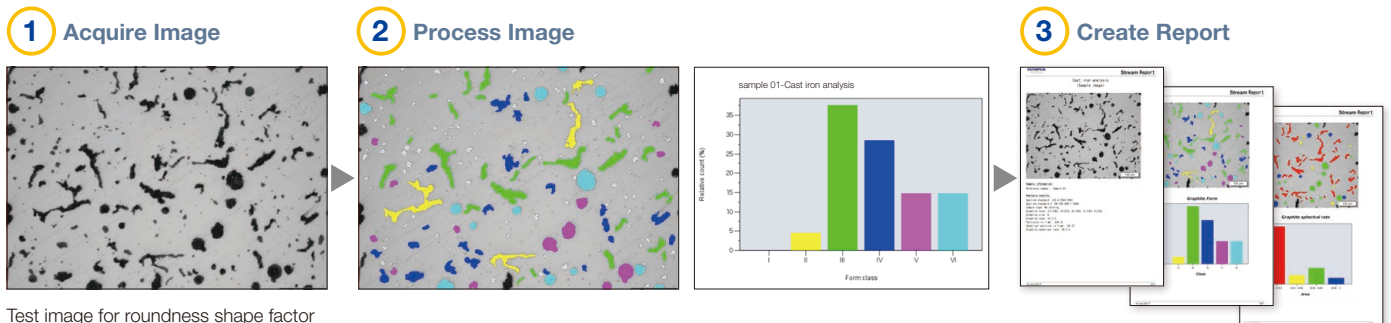

Efficient Report Generation

Creating a report can often take longer than capturing the image and taking the measurements. OLYMPUS Stream software provides intuitive report creation to repeatedly produce smart and sophisticated reports based on predefined templates. The software can be configured so that the magnification is printed along with individual images.

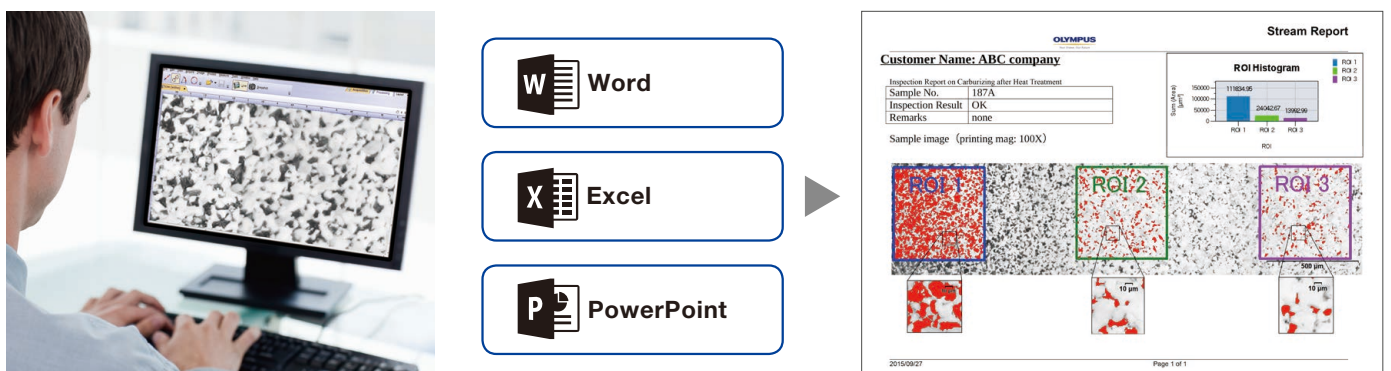

Advanced Imaging Technology

Proven optics and digital imaging technology deliver quality inspection data

Olympus' history of developing high-quality optics and advanced imaging capabilities has led to quality microscopes that offer exceptional measurement accuracy.

Reliable Optical Performance: Wavefront Aberration Control

The optical performance of objective lenses directly impacts the quality of the observation images and analysis results. Olympus UIS2 high-magnification objectives are designed to minimize wavefront aberrations, delivering reliable optical performance.

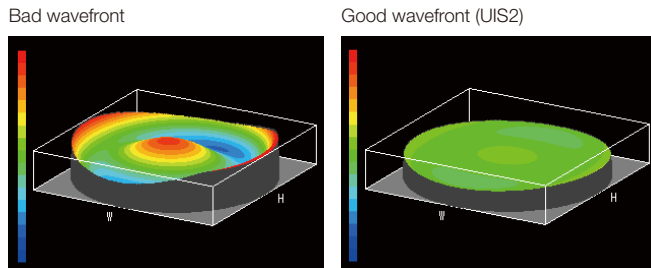

Consistent Color Temperature: High-Intensity White LED Illumination

The GX53 microscope utilizes a high-intensity white LED light source for reflected and transmitted illumination. The LED maintains a consistent color temperature regardless of intensity for reliable image quality and color reproduction. The LED system provides efficient, long-life illumination that is ideal for materials science applications.

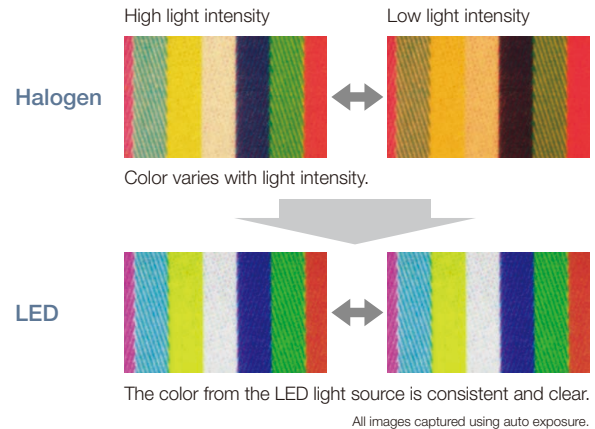

Entirely Clear Image: Image Shading Correction



OLYMPUS Stream software features shading correction to mitigate shading in the corners of an image. When used with intensity threshold settings, shading correction provides a more precise analysis.

Stainless steel (Binarized image)



Shading correction produces even illumination across the field of view.

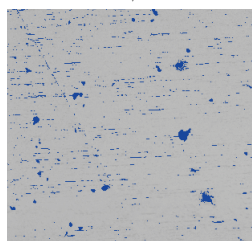

Precise Measurements: Auto Calibration



Similar to digital microscopes, automatic calibration is available when using OLYMPUS Stream software. Auto calibration helps eliminate the impact of human variability on the calibration process, leading to more reliable measurements. The software automatically calculates the correct calibration from an average of multiple measurement points, minimizing variance and maintaining a greater consistency.

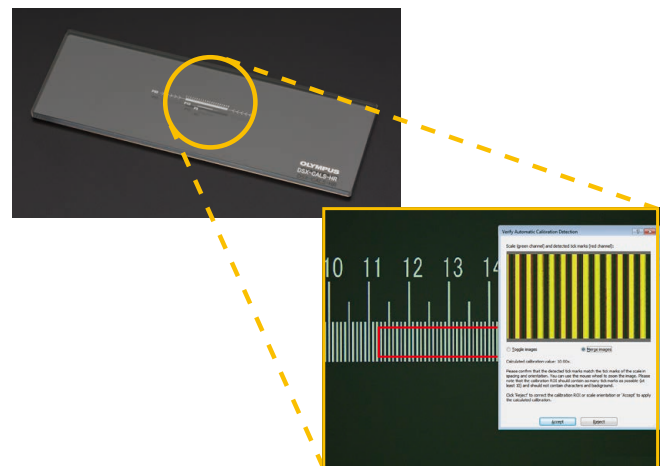

Applications

Reflected light microscopy spans a range of applications and industries. Below are just a few examples of what can be achieved using different observation methods.

Polished sample of AISI

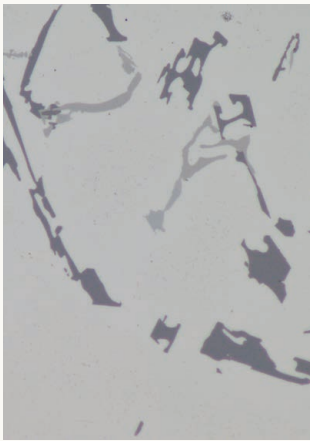

Brightfield

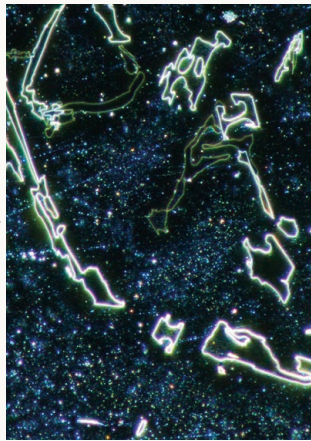

Darkfield

Brightfield is a common observation method to observe reflected light from a sample by illuminating it straight on.

Darkfield is used to observe scattered or diffracted light from a sample, so imperfections clearly stand out. Inspectors can identify even minute scratches or flaws.

Spheroidal graphite cast iron

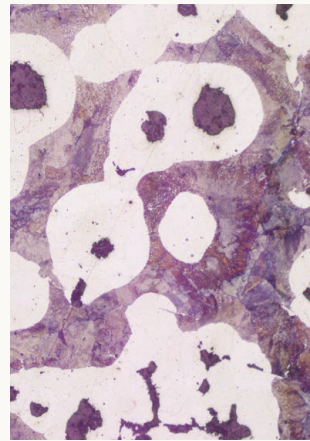

Brightfield

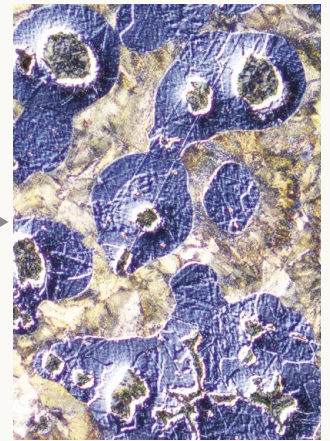

DIC observation

Differential interference contrast (DIC) is an observation technique where the height of a sample, normally not detectable in brightfield, is visible as a relief, similar to a 3D image with improved contrast. It is ideal for inspections of samples that have very minute height differences, including metallurgical structures and minerals.

Aluminum alloy

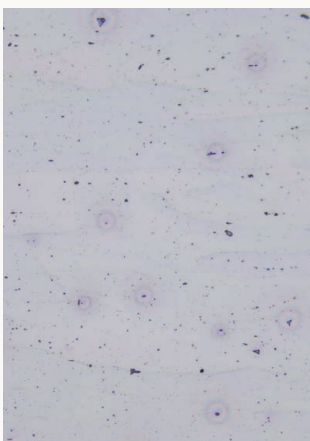

Brightfield

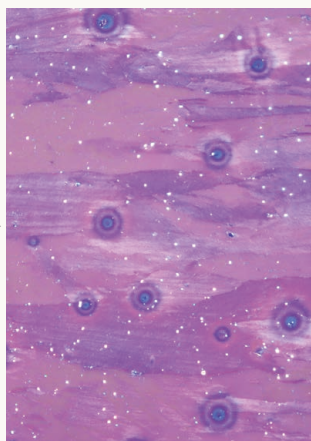

Polarized light observation

Polarized light observation represents a material's texture and crystal condition brightly. It is suitable for metallurgical structures such as the growth pattern of graphite on nodular cast iron and minerals.

Electronic device



Brightfield

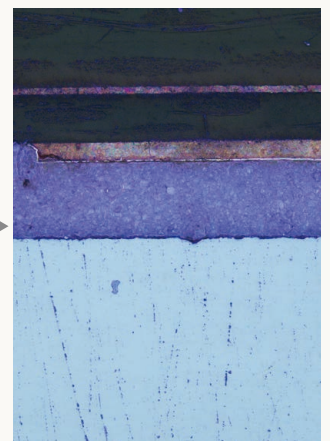

MIX observation: Brightfield + Darkfield

MIX observation combines brightfield and darkfield illumination methods, showing both the sample's color and structure.

The above MIX observation image clearly reproduces the device's color and texture as well as the condition of the adhesive layer.

Customizable

Choose the Components You Need

The GX53 microscope is designed to enable users to choose a variety of optical components to suit individual inspection and application requirements. The system can utilize all available observation methods. Users can also select from a variety of OLYMPUS Stream image analysis packages to meet image acquisition and analysis needs.

GX53 Reflected/Transmitted Light Combination

The GX53 microscope frame can be configured for both reflected and transmitted light with manual, coded, or motorized components.



Scales for Metallurgical Analysis

Glass scales can be inserted into the eyepiece to conduct observations that comply with industry standards. Grain size reticles, squared circles, and calibration scales are also available for each objective.

Scale slider

1	GX-SLM	Scale slider, attachable 3 glass scales maximum
2	GX51-SLMG5	Scale glass for 5× objective, scale length: 200 μm
3	GX51-SLMG10	Scale glass for 10× objective, scale length: 100 μm
4	GX51-SLMG20	Scale glass for 20× objective, scale length: 50 μm
5	GX51-SLMG50	Scale glass for 50× objective, scale length: 10 μm
6	GX51-SLMG100	Scale glass for 100×, scale length: 10 μm
7	GX51-SLMGS	Grain size scale, applied to JIS G 0551, ISO 643 and ASTM E112 AUSTENITE GRAINS IN STEEL PLATE IV No.1 to 8
8	GX51-SLMGH	Lattice pattern, applied to JIS G 0555
9	GX-SLMG	Parfocal glass to adjust the light path length

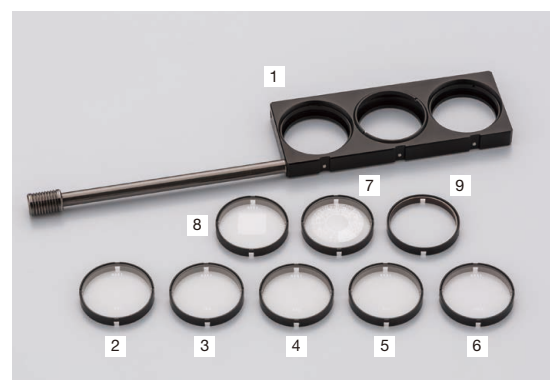

Build Your System Your Way

Microscope Frame

The GX53 microscope has a built-in power supply for reflected light. The camera adaptor port at the front of the microscope enables users to display live and captured images without using a trinocular tube. Choose various accessories such as a stage mirror that enables users to check the observation position and the magnification of the objectives.

Microscope frames

	■ Possible	Reflected light	Transmitted light
1	GX53F	■	■

Accessories

2	CK40M-MS	Observation position check mirror
-	COVER-021	Dust cover for GX53 system



Transmitted Illumination Unit

Condensers collect and focus transmitted light and are used for transmitted light observation.

1	IX2-ILL100	Stand for transmitted illumination, attachable BF/POL lamp housing for LED (BX3M-LEDT) and halogen (U-LH100L-3)
2	PMG3-LWCD	Condenser for transmitted light observation, condenser (NA 0.6, WD 12 mm) with aperture stop



Light Sources

Choose the light source and power supply you need to illuminate your sample. Choose the appropriate light source for your observation method.

Standard LED light source configuration

1	BX3M-LEDR	LED lamp housing for reflected light
2	BX3M-LEDT	LED lamp housing for transmitted light
3	BX3M-PSLED	Power supply for LED lamp housing (required for transmitted light only)

High intensity light source configuration

4	MX-HGAD	High intensity light adapter
5	U-LLGAD	Liquid light guide adapter
6, 7	U-LLG150 (300)	Liquid light guide, length: 1.5 m (3 m)
8	U-HGLGPS	High intensity light source (mercury), including one SHI-1300L in the standard package
-	SHI-1300L	130 W mercury lamp
9, 10	U-LH100HG (HGAP0)	Mercury lamp housing, chromatic aberration correction type
-	USH-1030L	100 W mercury lamp
11	U-CLA	Flexible extension handle for mercury lamp housing
12	U-RFL-T	Power supply for 100 W mercury lamp
13	U-CST	Optical axis adjustment sample for mercury lamp housing

Halogen light source configuration

14	U-LH100L-3	Halogen lamp housing
-	12V100W HAL (-L)	100 W halogen lamp (long life type)
15	U-RMT	Extender cable for halogen lamp housing, cable length 1.7 m (requires cable extension when necessary)
16, 17	TH4-100 (200)	100 V (200 V) specification power supply for 100 W/50 W halogen lamp
18	TH4-HS	Hand switch to change the light intensity of halogen (dimmer TH4-100 (200) without hand switch)

Double lamp housing configuration

19	U-DULHA	Dual lamp housing attachment
		High intensity light source configuration (MX-HGAD is not required when using U-LH100HG (HGAP0))
		— BX3M-LEDR (with standard LED light source configuration)
		— Halogen light source configuration



Tubes

Select tubes for imaging through the eyepieces or for use with a camera. Choose the tube you need by imaging type and level of ergonomic comfort.

		FN (mm)	Type	Angle type	Image	Diopter adjustment mechanism	Turret mechanism
1	U-BI90	22	Binocular	Fixing	Reverse	Right only	–
2	U-BI90CT	22	Binocular	Fixing	Reverse	Right only	4 positon*
3	U-TBI90	22	Binocular	Tilting	Reverse	Right only	–
4	U-TR30H-2	22	Trinocular	Fixing	Reverse	Right only	–

*4 positions are O, CT, O, and S.

(O: Empty, CT: Centering telescope for adjustment of aperture stop, S: Shutter preventing light from eyepiece.)

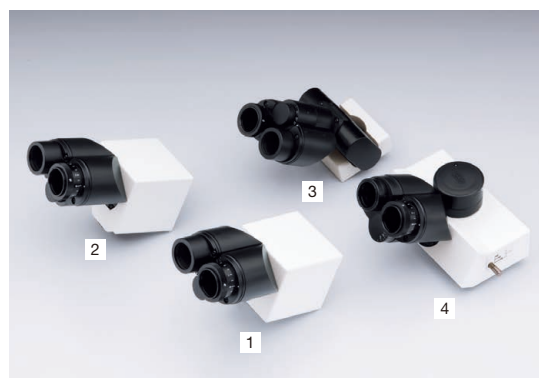

Eyepieces

Eyepiece for viewing directly into the microscope. Select based on the desired field of view.

	■: Possible	FN (mm)	Diopter adjustment mechanism	Built-in cross reticle
1	WHN10X	22		
2	WHN10X-H	22	■	
3	CROSS WHN10X	22	■	■



Intermediate Tubes

Various accessories for multiple purposes. For use between the tube and microscope frame.

1	U-CA	Magnification changer (1×, 1.25×, 1.6×, 2×)
2	U-ECA	Magnification changer (1×, 2×)
3	U-EPA2	Eyepoint adjuster : + 30 mm
4	GX-SPU	Attachable camera adapter with side port
5	IX-ATU	Attachable tube : U-TR30H-2

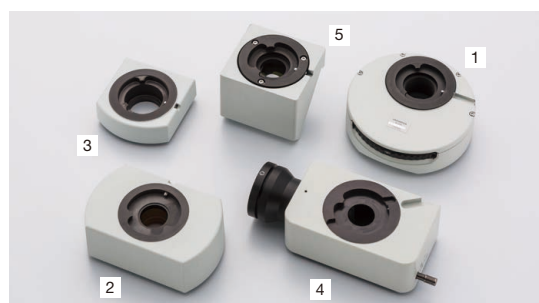

Camera Adapters

Adaptors are used to add a camera. Select the adaptor based on the field of view and magnification. The actual observation range can be calculated using the following formula: actual field of view (diagonal mm) – viewing field (viewing number) / objective magnification.

		Magnification	Centering adjustment (mm)	Camera image area (field number) (mm)			Attachable unit
				2/3 in.	1/1.8 in.	1/2 in.	
1	GX-TV0.7XC	0.7	–	15.3	12.6	11.4	GX53F
2	GX-TV0.5XC	0.5	–	21.4	17.6	16	GX53F
3	U-TV1X-2 with U-CMAD3	1	–	10.7	8.8	8	GX-SPU
4	U-TV1XC	1	ø2	10.7	8.8	8	GX-SPU
5	U-TV0.63XC	0.63	–	17	14	12.7	GX-SPU
6	U-TV0.5XC-3	0.5	–	21.4	17.6	16	GX-SPU
7	U-TV0.35XC-2	0.35	–	–	–	22	GX-SPU
8	U-TV0.25XC*	0.25	–	–	–	–	GX-SPU
9, 10, 11	IX-TVAD with U-FMT/U-CMT	1	–	10.7	8.8	8	U-TR30H-2

For information on digital cameras, please visit our website at <http://www.olympus-ims.com/en/microscope/dc/>

* A camera can be attached when the image area (field number) is less than 1/3 inch.



Nosepieces

Nosepieces are used to attach objectives and sliders. Choose your nosepiece based on the number of objectives you want to attach, objective type, and whether or not you are using a slider attachment.

	■: Possible	Type	Holes	BF	DF	DIC	MIX	ESD	Number of centering holes
1		Manual	5	■					
2		Coded	5	■				■	
3		Manual	4	■		■			4
4		Manual	6	■		■			
5		Manual	6	■		■		■	
6		Manual	6	■		■			2
7		Manual	7	■		■			
8		Coded	6	■		■			
9		Coded	7	■		■			
10		Manual	5	■	■				
11		Manual	5	■	■	■	■		
12		Manual	5	■	■	■	■		2
13		Manual	6	■	■	■	■		
14		Coded	5	■	■	■	■	■	
15		Coded	6	■	■	■	■	■	



Sliders

Select the slider to complement traditional brightfield observation. The DIC slider provides topographic information about the sample with options to maximize contrast or resolution. The MIX slider provides illumination flexibility with a segmented LED source in the darkfield path.

	Type	Amount of shear	Recommended objectives
1	U-DICR	Standard	MPLFLN, MPLAPON, LMPLFLN, and LCPLFLN-LCD
2	U-DICRH	Resolution	MPLFLN, MPLAPON
3	U-DICRHC	Contrast	LMPLFLN and LCPLFLN-LCD

MIX slider for MIX observation

	Type	Available objectives
4	U-MIXR	MIX slider



Control Box Hand Switches

Control boxes for connecting the microscope's hardware with a PC and hand switches for hardware display and control.

Control box

1	BX3M-CBFM	Control box for the BCFM system
2	GX-IFRES	Box for OB indicator of the hand switch BX3M-HS; If the GX-IFRES connects to BX3M-CBFM, U-CBS is not needed when using OLYMPUS Stream/DP2-SAL
3	U-CBS	Control box for coded functions

Hand switch

4	BX3M-HS	MIX observation control, indicator of coded/motorized hardware, programmable software function button of OLYMPUS Stream
5	U-HSEXP	Operate a camera's shutter

Cable

-	U-MIXRCBL	U-MIXR cable, cable length: 0.5 m
---	-----------	-----------------------------------



Stages

Stages and stage plates for sample placement. Select based on sample shape and size.

Stages

1	IX2-SFR	Flexible right handle stage, the handle grip is about 260 mm below the stage surface
2	GX-SFR	Flexible right handle stage, the handle grip is about 280 mm below the stage surface
3	GX-SVR	Right handle stage
4	IX2-GS	Gliding stage, the stage plate is incorporated (diameter: $\phi 110$ mm, shape of hole: $\phi 25$ mm teardrop, material: aluminum alloy)
5	IX-SVL-2	Flexible left handle (short) stage, stage plate is incorporated (diameter: 110 mm, shape of hole: $\phi 25$ mm teardrop, material: aluminum alloy)

Stage plates

		Plate area	Hole type	Material
6	CK40-CPG30	$\phi 110$ mm	Diameter $\phi 30$ mm	Glass
7	IX-CP50	$\phi 110$ mm	Diameter $\phi 50$ mm	Brass
8	IX2-GCP	$\phi 110$ mm	Teardrop $\phi 25$ mm	Brass
9	GX-CP	$\phi 110$ mm	Teardrop $\phi 12$ mm	Brass
			Long hole (74 × 25 mm)	Amber alloy

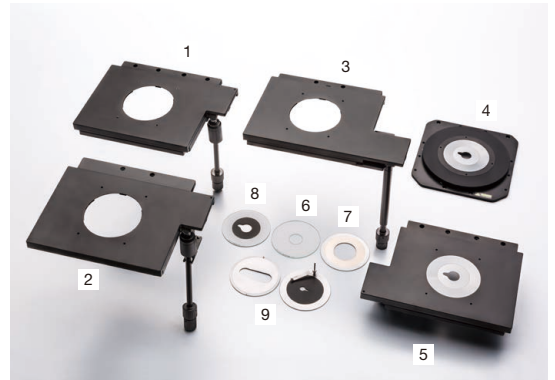

Optical Filters

Optical filters convert sample exposure light to various types of illumination. Select the appropriate filter for your observation requirements.

BF, DF, FL

1, 2, 3	U-25ND50, 25, 6	Transmittance 50%/25%/6%
4	U-25LBD	Daylight color filter
5	U-25LBA	Halogen color filter
6	U-25IF550	Green filter
7	U-25L42	UV cut filter
8	U-25Y48	Yellow filter
9	U-25FR	Frost filter
10	GX-FSL	Used by combining GX51 filters, attachable filter quantity: 3
11, 12	└25ND25, 6	$\phi 25$ mm transmittance 25%/6%
13	└25LBD	$\phi 25$ mm daylight color filter
14	└25IF550	$\phi 25$ mm green filter
15	└25Y48	$\phi 25$ mm yellow filter



POL, DIC

16	GX-AN	Analyzer for reflected light; polarization direction is fixed
17	GX-AN360	Analyzer for reflected light; polarization direction is 360 degree rotatable
18	GX-PO3	Polarizer for reflected light; polarization direction is fixed
19	GX-POTP	Tint plate polarizer for reflected light; polarization direction is fixed

Transmitted light

20	U-POT	$\phi 45$ mm polarizer filter
21	43IF550-W45	$\phi 45$ mm green filter for transmitted light
22	45-LBD-IF	$\phi 45$ mm daylight color filter for transmitted light
23, 24	45-ND25, 6	$\phi 45$ mm transmittance 25%/6% for transmitted light

Other

25	U-25	Empty filter, used by combining user's $\phi 25$ mm filters
----	------	---

UIS2 Objectives

Objectives magnify the sample. Select the objective that matches the working distance, resolving power, and observation method for the application.

Objectives	Magnifications	NA	W.D. (mm)	Cover glass thickness*2 (mm)	Resolution*3 (μm)
MPLAPON	1 50X	0.95	0.35	0	0.35
	2 100X	0.95	0.35	0	0.35
MPLFLN	3 1.25X*4*5	0.04	3.5	0-0.17	8.39
	4 2.5X*5	0.08	10.7	0-0.17	4.19
	5 5X	0.15	20	0-0.17	2.24
	6 10X	0.30	11	0-0.17	1.12
	7 20X	0.45	3.1	0	0.75
	8 40X*1	0.75	0.63	0	0.45
	9 50X	0.80	1	0	0.42
SLMPLN	10 100X	0.90	1	0	0.37
	11 20X	0.25	25	0-0.17	1.34
	12 50X	0.35	18	0	0.96
LMPLFLN	13 100X	0.60	7.6	0	0.56
	14 5X	0.13	22.5	0-0.17	2.58
	15 10X	0.25	21	0-0.17	1.34
	16 20X	0.40	12	0	0.84
MPLN*4	17 50X	0.50	10.6	0	0.67
	18 100X	0.80	3.4	0	0.42
	19 5X	0.10	20	0-0.17	3.36
	20 10X	0.25	10.6	0-0.17	1.34
LCPLFLN-LCD	21 20X	0.40	1.3	0	0.84
	22 50X	0.75	0.38	0	0.45
	23 100X	0.90	0.21	0	0.37
MPLFLN-BD*6	24 20X	0.45	8.3-7.4	0-1.2	0.75
	25 50X	0.70	3.0-2.2	0-1.2	0.48
	26 100X	0.85	1.2-0.9	0-0.7	0.39
	27 5X	0.15	12	0-0.17	2.24
	28 10X	0.30	6.5	0-0.17	1.12
MPLFLN-BDP*6	29 20X	0.45	3	0	0.75
	30 50X	0.80	1	0	0.42
	31 100X	0.90	1	0	0.37
	32 150X	0.90	1	0	0.37
	33 5X	0.15	12	0-0.17	2.24
LMPLFLN-BD*6	34 10X	0.25	6.5	0-0.17	1.34
	35 20X	0.40	3	0	0.84
	36 50X	0.75	1	0	0.45
	37 100X	0.90	1	0	0.37
	38 5X	0.13	15	0-0.17	2.58
MPLN-BD*4*6*7	39 10X	0.25	10	0-0.17	1.34
	40 20X	0.40	12	0	0.84
	41 50X	0.50	10.6	0	0.67
	42 100X	0.80	3.3	0	0.42
MPLN-BD*4*6*7	43 5X	0.10	12	0-0.17	3.36
	44 10X	0.25	6.5	0-0.17	1.34
	45 20X	0.40	1.3	0	0.84
	46 50X	0.75	0.38	0	0.45
	47 100X	0.90	0.21	0	0.37



*1 The MPLFLN40X objective is not compatible with the differential interference contrast microscopy.

*2 0: For viewing specimens without a cover glass.

*3 Resolutions calculated with aperture iris diaphragm wide open.

*4 Limited up to FN 22, no compliance with FN 26.5.

*5 Analyzer and polarizer are recommended for usage with MPLFLN1.25X and 2.5X.

*6 BD: Brightfield/darkfield objectives.

*7 Slight vignetting may occur in the periphery of the field when MPLN-BD series objectives are used with high-intensity light sources, such as mercury and xenon, for darkfield observation.

■ Definition for Objective Lens Abbreviations

M P L (Plan) F L N 1 0 0 B D

M: Metallurgical (no cover)
LM: Long working distance metallurgical use
SLM: Super long working distance metallurgical use
LC: Observation through substrate

PL: Plan/
 Corrects field curvature of the periphery of the image plane

None: Achromat/
 Corrects aberration at two wavelengths of blue and red
FL: SemiApochromat/
 Corrects chromatic aberration in the visible range (violet to red)
APO: Apochromat/
 Optimally corrects chromatic aberration in the entire visible band (violet to red)

Number:
 Objective lens magnification

None: Brightfield
BD: Brightfield/Darkfield
BDP: Brightfield/Darkfield/
 Polarizing
LCD: LCD

GX53 System Diagram

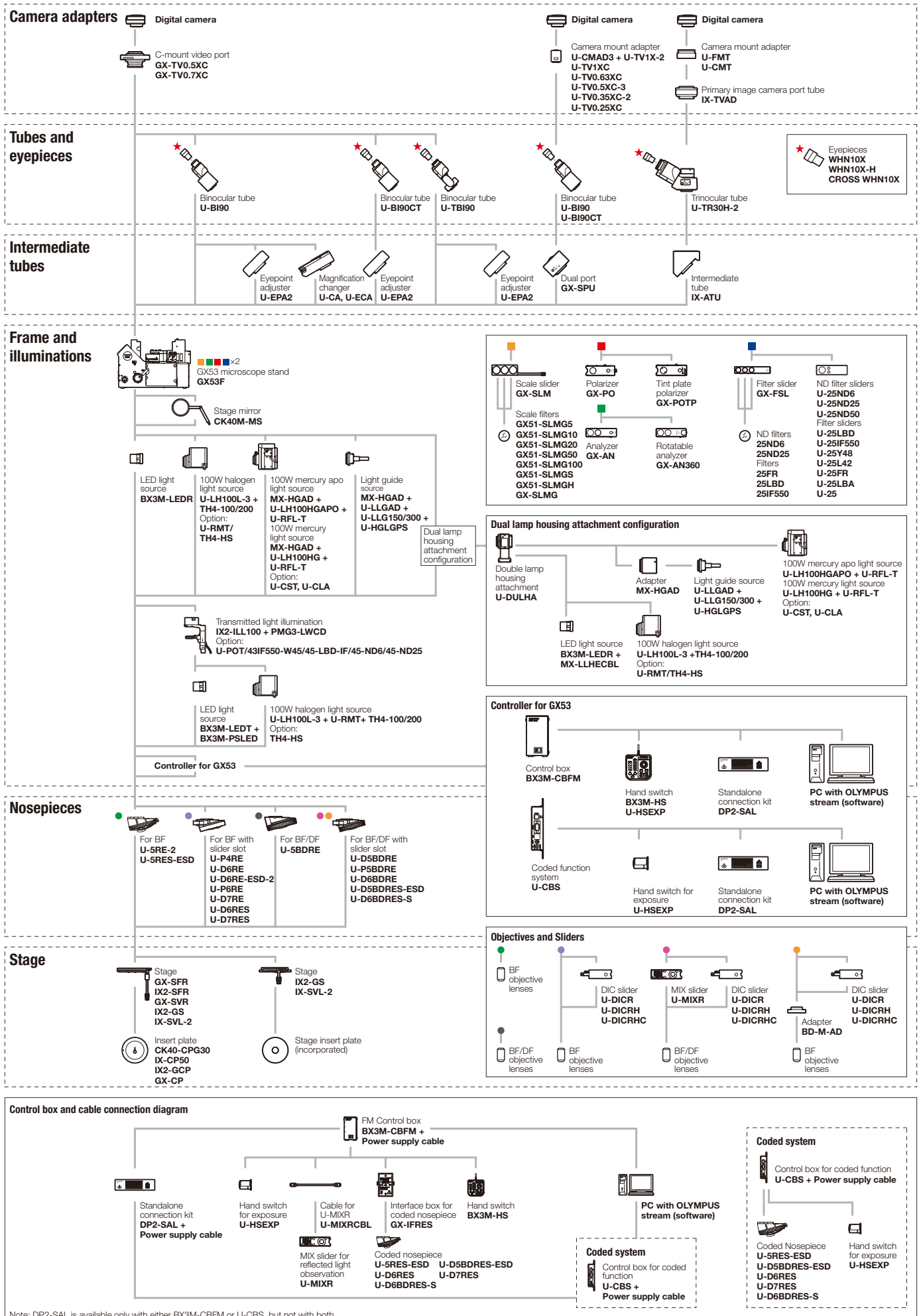

Specifications

		GX53
Optical system		UIS2 optical system (infinity-corrected)
Microscope frame	Reflected light illumination	Manual brightfield/darkfield selection by mirror unit Manual field stop/aperture stop switch with centering Light source: White LED (with Light Intensity Manager) /12 V, 100 W halogen lamp/100 W mercury lamp/light guide source Observation mode: brightfield, darkfield, differential interface contrast (DIC)*1, simple polarizing*1, MIX observation (4 directional darkfield)*2 *1 Slider for exclusive use of this observation is required. *2 MIX observation configuration is required.
	Transmitted light illumination (optional)	Stand for transmitted light (IX2-ILL100: with field stop) is required PMG3-LWCD: Condenser (NA 0.6, WD 12 mm) with aperture stop Light source: White LED (with Light Intensity Manager) 12 V, 100 W halogen lamp Observation modes: brightfield, simple polarizing
	Imprinting of scale	All ports reversed positions (up/down) from observation positions seen through the eyepiece
	Output front port (optional)	Camera and DP system (reversed image, special camera adapter for GX)
	Output side port (optional)	Camera, DP system (upright image)
	Electrical system	Reflected light illumination Built-in LED power supply for reflected light illumination Continuously-variable light intensity dial Input rating 5 V DC, 2.5 A (AC adapter 100–240 V, AC 0.4 A, 50 Hz/60 Hz) Transmitted light illumination (requires the optional BX3M-PSLED power supply) Continuously-variable light intensity dial by voltage Input rating 5 V DC, 2.5 A (AC adapter 100–240 V, AC 0.4 A, 50 Hz/60 Hz) External interface (requires the optional BX3M-CBFM control box) Coded nosepiece connector × 1 MIX Slider (U-MIXR) connector × 1 Handset (BX3M-HS) connector × 1 Handset (U-HSEXP) connector × 1 RS-232C connector × 1, USB 2.0 connector × 1
Focus	Rack and pinion with roller guide Manual, coarse and fine coaxial handle; focus stroke 9 mm (2 mm above and 7 mm below the stage surface) Fine handle stroke per rotation: 100 μm (min. scale: 1 μm) Coarse handle stroke per rotation: 7 mm With torque adjustment ring for coarse focusing With upper limit stopper for coarse focusing	
Tubes	Widefield (FN 22)	Inverted: binocular (U-BI90, U-BI90CT), trinocular (U-TR30H-2), tilting binocular (U-TBI90)
Nosepiece		Brightfield Holes: 4 to 7 pcs, Type: Manual/Coded, Centering: Enabled/Disabled Brightfield/darkfield Hole: 5 to 6 pcs, Type: Manual/Coded, Centering: Enabled/Disabled
Stage		Right handle stage for GX (X/Y stroke: 50 × 50 mm, max. load 5 kg) Flexible right handle stage, left short handle stage (each X/Y stroke: 50 × 50 mm, max. load 1 kg) Gliding stage (max. load 1 kg) A set of teardrop and long hole types
Weight		Approx. 25 kg (microscope frame 20 kg)
Environment		<ul style="list-style-type: none"> Indoor use Ambient temperature: 5 to 40 °C (45 to 100 °F) Maximum relative humidity: 80% for temperatures up to 31 °C (88 °F) (without condensation) In case of over 31 °C (88 °F), the relative humidity is decreased linearly through 70% at 34 °C (93 °F), 60% at 37 °C (99 °F), and to 50% at 40 °C (104 °F). Pollution degree: 2 (in accordance with IEC60664-1) Installation/Oversvoltage category: II (in accordance with IEC60664-1) Supply voltage fluctuation: ±10 %

Dimensions

GX53

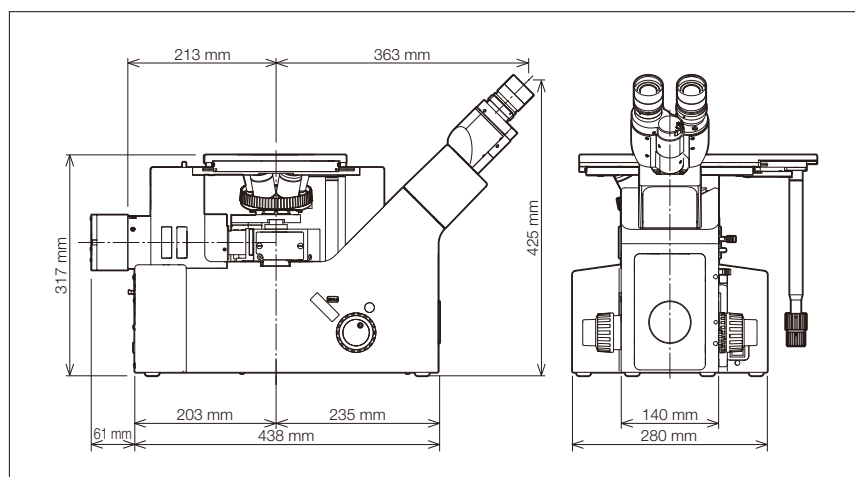

Olympus offers an extensive product line for materials science and industrial microscopy. Learn more about the LEXT 3D measuring laser microscope and DSX series digital microscopes on our website, www.olympus-ims.com.



NEW

LEXT 3D Measuring Laser Microscope

Power and speed are the hallmarks of the LEXT OLS5000 microscope. Owing to its high-resolution imaging and fast acquisition, the microscope delivers precise non-contact 3D observations and measurement of surface topography with impressive efficiency.



DSX Digital Microscope

The DSX series' advanced digital technology delivers surpassing image quality with operating simplicity, making it suitable for users of any experience level. The DSX microscope's intelligent interface is as easy-to-use as using a smartphone or tablet and backed by guaranteed accuracy and repeatability for 2D and 3D measurements.

www.olympus-ims.com

OLYMPUS[®]

OLYMPUS CORPORATION
Shinjuku Monolith, 2-3-1 Nishi-Shinjuku, Shinjuku-ku, Tokyo 163-0914, Japan

- OLYMPUS CORPORATION is ISO14001 certified.
- OLYMPUS CORPORATION is ISO9001 certified.
- This product is designed for use in industrial environments for the EMC performance. Using it in a residential environment may affect other equipment in the environment.
- All company and product names are registered trademarks and/or trademarks of their respective owners.
- Images on the PC monitors are simulated.
- Specifications and appearances are subject to change without any notice or obligation on the part of the manufacturer.
- Illumination devices for microscope have suggested lifetimes. Periodic inspections are required. Please visit our web site for details.

N8600936-092017